

TPS (HDBaseT™) Extender for HDMI with Local Monitor Out

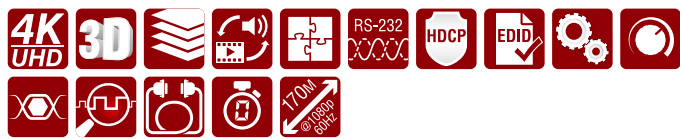

Part No: 9154 0011



Highlight Features

- 4K/UHD (30Hz RGB 4:4:4, 60Hz YCbCr 4:2:0) and 3D capabilities
- Extends HDMI1.4 + Audio + Ethernet + RS-232 + IR + GPIO over a single CAT5e (or higher class) cable up to 170 m distance*
- Event Manager
- 10/100 Ethernet extension
- Bi-directional RS-232 and IR
- GPIO control port
- Embeds analog audio

*Depends on cable category and quality

The HDMI-TPS-TX220 is a flagship model in the Lightware TPS (HDBaseT™ Transmitter) product family. The device can transmit universal video, audio and control up to a 170 meter distance over a single CAT cable in dynamically changing environments such as small board rooms and classrooms. The extender was designed to handle HDMI1.4 digital video signals and analog stereo audio from local inputs or HDMI Embedded Audio up to 8 Channel PCM or HBR audio. Analog audio is converted to digital format. The device has a local video output. The video and the Embedded Audio of the local output is the same as the one transmitted via TPS link. The HDMI- TPS-TX220 handles HDCP encryption. Using the factory, custom or transparent EDID emulation the user can fix and lock EDID data on each input connector. Advanced EDID Management forces the required resolution from any video source and fixes the output format conforming the system requirements. The unit offers bi-directional and transparent IR, RS232 and Ethernet transmission. Both the RS232 and IR connections support command injection. Remote powering is available through the single CAT 5e - CAT 7 cable, but local power supply can also be used. All devices can be mounted on a rack shelf or used standalone. HDMI-TPS-TX220 is compatible with both HDBaseT™ extenders and

HDBaseT™ and the HDBaseT Alliance logo are trademarks of the HDBaseT Alliance

Standalone Application

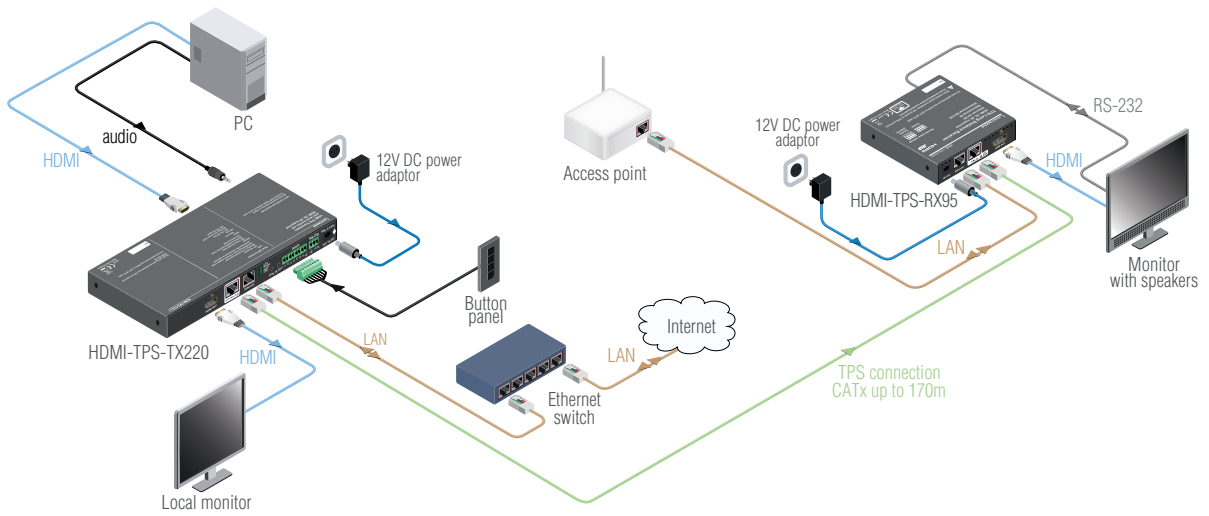

Application Diagram

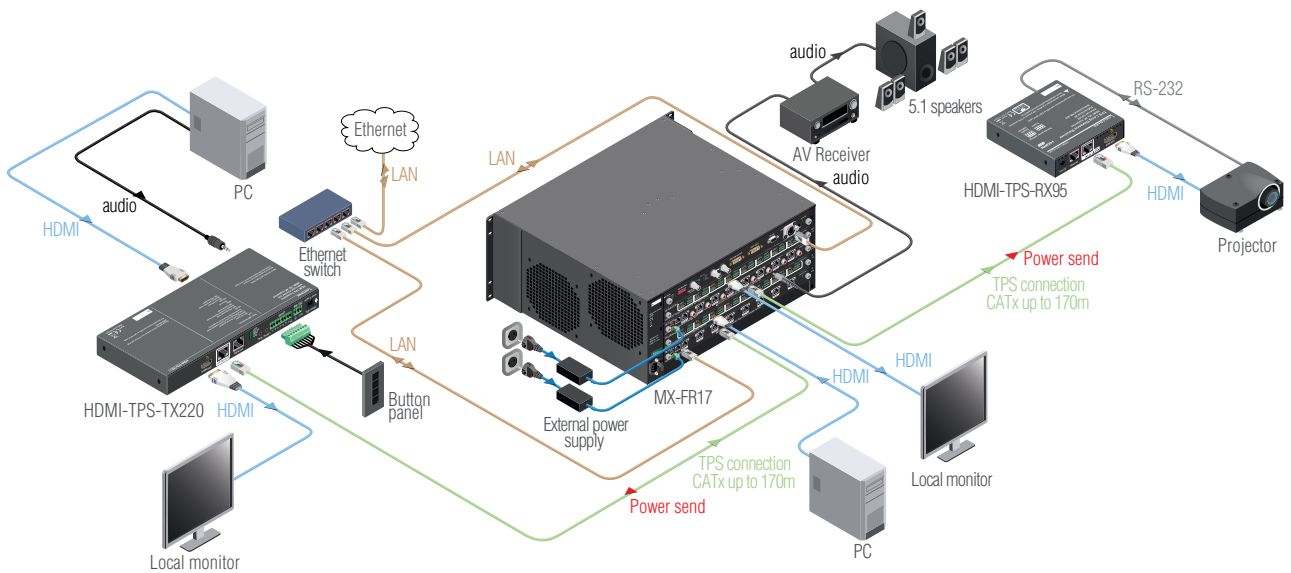

Transmitter Front and Back View



HDMI-TPS-TX220

HDMI-TPS-TX220

Event Manager

The Event Manager is a smart, built-in feature in the Lightware HDBaseT compatible TPS extender family, the MODEX line and in some select matrix switchers like the MMX6x2-HT series units. The feature is available through the freely downloadable Lightware Device Controller software.

The Event Manager was developed to handle tasks from the most simple to expert ones, like controlling the rolling shutter, the air conditioning system or the lights based on any condition changes on the media ports, such as a new source being connected or removed.

Event Manager application is continuously updated with additional features via firmware upgrades: a delay can be added between the condition and the action and more actions can be triggered by a single condition change. With the help of the 'condition count' and 'action test' features, the predefined settings can be tested before going live. The system can recognize infrared commands which can also be set as conditions, and commands can also be sent via Ethernet.

Event Manager Wizard

Assigning an action to a condition is quick and easy with the Wizard function of Event Manager.

The most typical examples of the currently selectable conditions and actions within the Event Manager Wizard are the following:

Conditions	
Video	Signal is detected on a port
Video	Signal is not detected on a port
Audio	Signal is detected on a port
Audio	Signal is not detected on a port
Audio	Signal type changes to PCM
Audio	Signal type changes to Compressed
Audio	Signal type changes to HBR
Audio	Signal type changes to Undefined (no signal)
IR	Infra code recognized
General	OPT / TPS link state changes to Connected
General	OPT / TPS link state changes to Disconnected

Actions	
Video	Switch input to output
Video	Enable autoselect output
Video	Disable autoselect on output
Ethernet	Send TCP command
Ethernet	Send UDP command
R232	Send RS232 message
EDID	Switch EDID
Audio	Set audio volume
Audio	Mute output
Audio	Unmute output
Audio	Increase/decrease volume

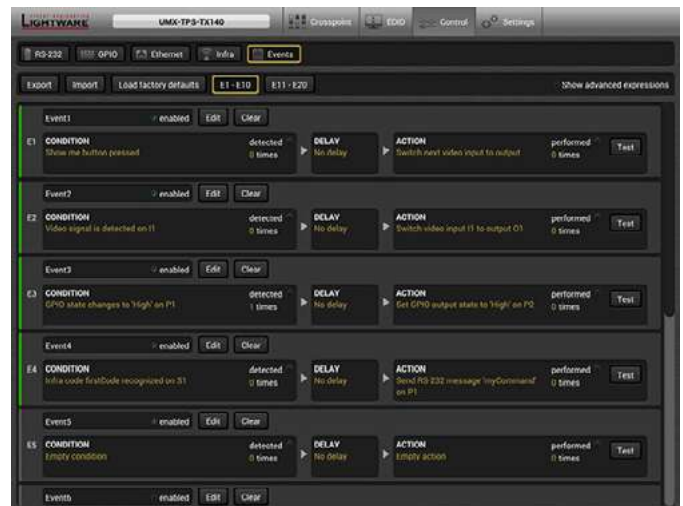

The Events menu contains separately configurable Events

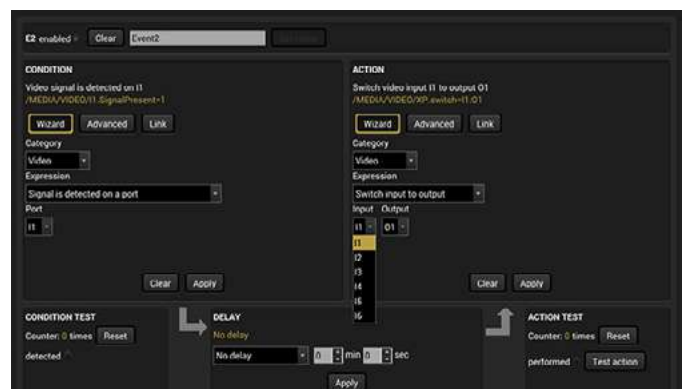

The Event Wizard makes the setup easy with simple dropdown options

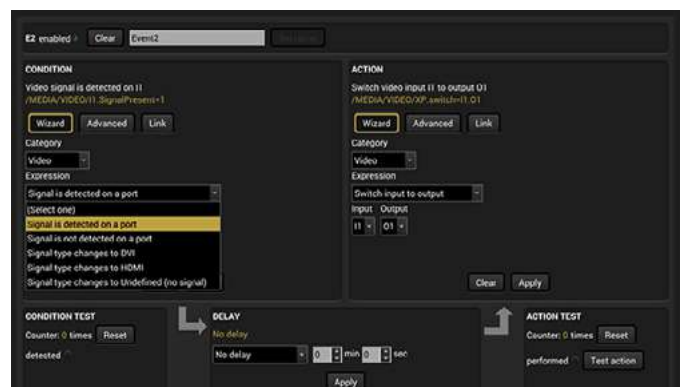

There are many default Expressions available to choose from

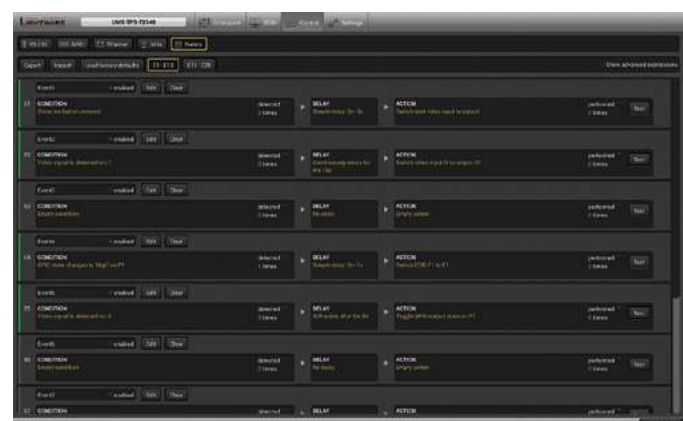

Green lines show which Event is configured and active, the rest stays grey

Event Example A

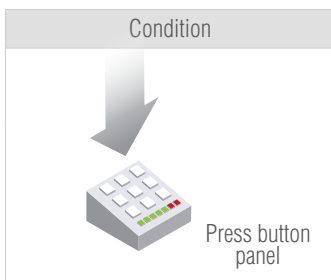
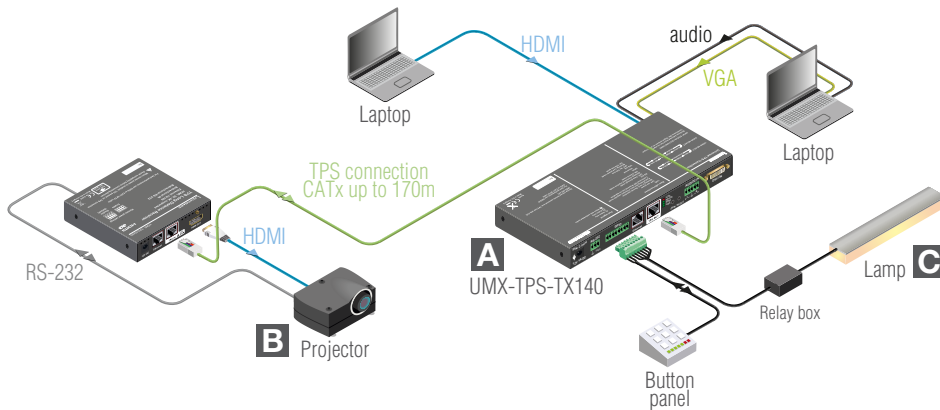

Condition	Action
	A Input select on the TPS transmitter
	B Switch on the projector using RS-232
	C Switch off the lamp using the transmitter's GPIO port

With a button panel connected through the GPIO port, the UMX-TPS-TX140 can be controlled from a remote location; input switching is available even if the transmitter is mounted under desk. In the example above there are three actions followed by a condition. When an input selector button is pressed on the remote button panel, the selected input port is switched to the output, the projector turns on.

Event Example B

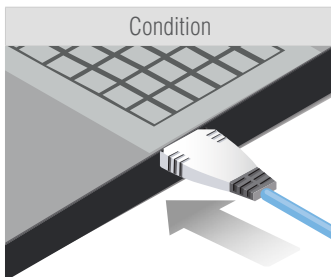
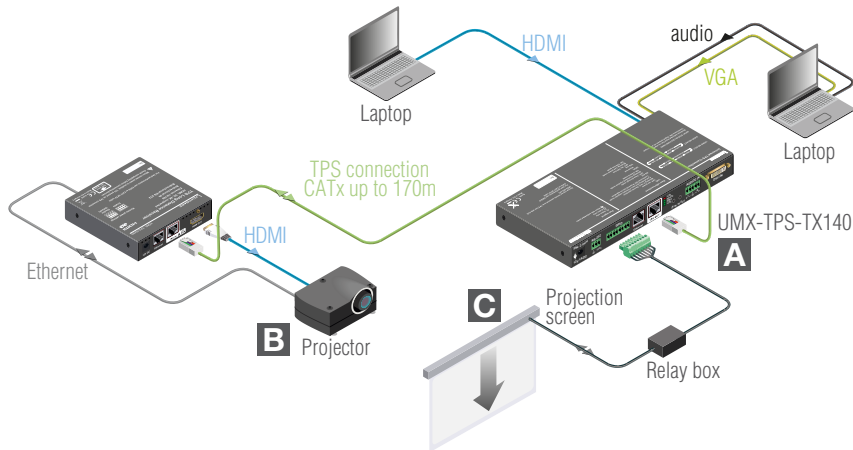

Condition	Action
	A Input select on the TPS transmitter
	B Switch on the projector using RS232
	C Roll down the projection screen using the transmitter's GPIO port

The projector and the rolling screen (via relay box) are connected to the UMX-TPS-TX140. When the user connects a laptop to the HDMI port of the transmitter, then the connected input is selected automatically, the screen goes down and the projector turns on to display the source.

Event Example C

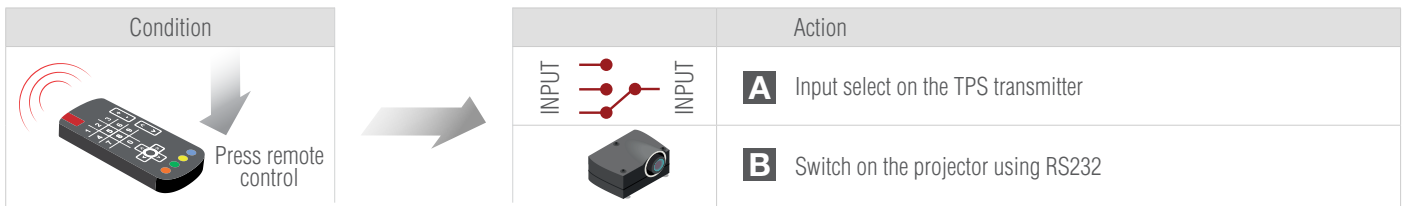
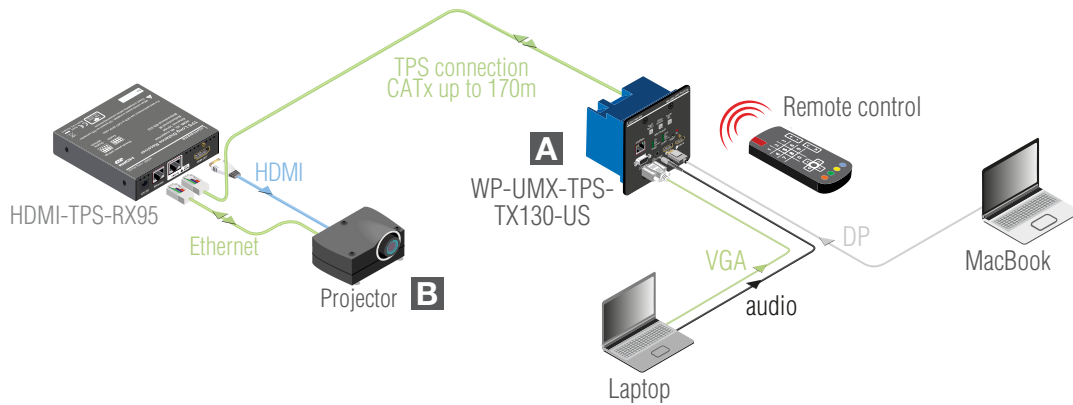

A MacBook with DisplayPort and another laptop with VGA and analog audio are connected to the WP-UMX-TPS-TX130-US wallplate which means there are two audio signals and two video signals connected. These inputs can be switched via IR using a remote control. For example the analog audio of the Laptop can be mixed with the DisplayPort video of the MacBook. The Event Manager helps the user assign actions like switching the projector on when the desired input is selected.

Currently the following Lightware products include Event Manager:

- UMX-TPS-TX120/130/140
- MMX6x2-HT200/210/220
- SW4-TPS-TX240
- WP-UMX-TPS-TX120-US/130-US
- MODEX

Port Diagram

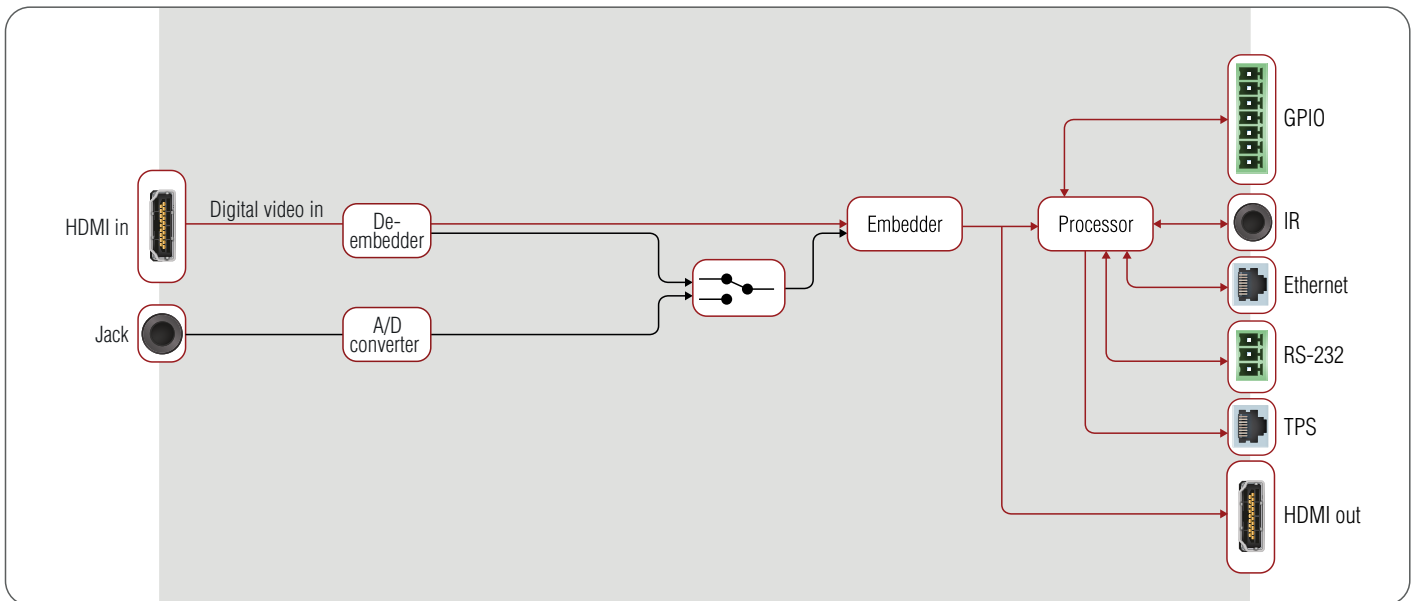

Compatibility Products

- MX Series matrix frames with MX-TPS-IB or MX-TPS2-IB
- HDMI-TPS-RX90
- DVI-HDCP-TPS-RX95
- HDMI-TPS-RX95
- TPS-PI-1P1

Applications

- Small classrooms
- Conference rooms, meeting rooms
- Control rooms
- Home cinemas

Features

- 4K/UHD (30Hz RGB 4:4:4, 60Hz YCbCr 4:2:0) and 3D capabilities
- Extends HDMI1.4 + Audio + Ethernet + RS-232 + IR + GPIO over a single CAT5e-CAT7e cable up to 170 m distance*
- Audio and video connectors: HDMI (input), HDMI (local output), Stereo jack
- Advanced EDID Manager
- Event Manager
- 10/100 Ethernet extension
- Bi-directional RS-232 and IR
- GPIO control port
- HDCP compliant, CEC
- Embeds analog audio

*Depends on cable category and quality

Specifications

Resolution:	Up to 4K / UHD (30Hz RGB 4:4:4 , 60Hz YCbCr 4:2:0), FullHD 1920x1080@60Hz
Digital audio formats:	Supports up to 8 channel PCM, Dolby TrueHD and DTS-HD Master Audio 7.1 formats
Input cable equalization:	Automatic max 20 m
EDID emulation:	Yes, Advanced EDID Management
EDID memory:	120 factory preset, 15 user programmable
HDCP pass-through:	Yes
RS-232 pass-through:	Yes, configurable
RS-232 (control option):	9600, 19200, 38400, 57600, 115200 Baud Rx,Tx (through CATx)(default: 57600)
Local power:	Universal power adaptor, DC 12V 2.5A
Power over TPS:	DC 48V 1 A
Power consumption:	8,5W (typ)
Enclosure:	1 mm metal
Dimensions:	221 W x 100.4 D x 26 H mm
Compliance:	CE
Warranty:	3 years

Connectors

Digital video input:	HDMI connector
Digital video output:	HDMI connector
Audio input:	3.5 mm stereo jack
Ethernet:	1 x RJ45
GPIO:	8-pole PHOENIX
IR:	3.5 mm jack
TPS output:	1 x RJ45
Serial port:	3-pole PHOENIX
Power:	Locking DC connector (2.1 / 5.5 mm)

Supplied Accessories



PSU-12VU Universal DC adaptor (Part No: 1180 0051)
Wall power adaptor with interchangeable plug for international use.
Universal input: 100-240 V AC, 50-60 Hz, output: 12 V DC, 2.5 A



IR emitter and IR eye (Part No: 1374 0003 TX, 1374 0002 RX)
IR emitter is supplied with TPS-TX, IR eye is supplied with TPS-RX units. Needed for IR extension.

Optional Accessories



Under desk mounting kit double (Part No: 5240 0276)
The UD-kit double makes it easy to mount multiple devices on any flat surface (e.g. furniture).



Rack shelf (Part No: 5240 0935)
1U high rack shelf provides mounting holes for fastening four quarter-rack sized units. Pocket sized devices can also be fastened on the shelf.

Max Cable Lengths Supported by the Available Firmware Versions

Resolution	Pixel Clock Rate	Cable Lengths (Auto / Longreach TPS mode)		
		CAT5e AWG24	CAT7 AWG26	CAT7 AWG23
1024x768@60Hz	65 MHz	100 m / 130 m*	90 m / 120 m*	120 m / 170 m*
1280x720p@60Hz	73.8 MHz	100 m / 130 m*	90 m / 120 m*	120 m / 170 m*
1920x1080p@60Hz / 24bpp	148.5 MHz	100 m / 130 m*	90 m / 120 m*	120 m / 170 m*
1920x1200@60Hz	152.9 MHz	100 m / NA*	90 m / NA*	120 m / NA*
1600x1200@60Hz	162 MHz	100 m / NA*	90 m / NA*	120 m / NA*
1920x1080@60Hz / 36bpp	223 MHz	70 m / NA*	70 m / NA*	100 m / NA*
3840x2160@30Hz UHD	297 MHz	70 m / NA*	70 m / NA*	100 m / NA*
4096x2160@30Hz 4K	297 MHz	70 m / NA*	70 m / NA*	100 m / NA*

Above values are valid when the extender is powered by a local adaptor; distances may decrease depending on the powering mode (local or remote) and cable quality.
* with Long reach operation mode which supports pixel clock frequencies up to 148,5 MHz.