

# MX9x9DVI-Slim, MX12x12DVI-Slim, MX16x16DVI-Slim

9 x 9, 12 x 12 or 16 x 16 ultra-thin and ultra-light DVI matrix switchers



Part No: 9131 0008 (9x9), 9131 0009 (12x12), 9131 00010 (16x16)



## Highlight features

- Industry's smallest and lightest frame
- Routing 9x9, 12x12 or 16x16 DVI 1.0 signals
- 1920x1200 or 2048x1080 maximal resolution

MX9x9DVI-Slim, MX12x12DVI-Slim and MX16x16DVI-Slim are today's smallest and lightest DVI matrix switchers that offer 9 Inputs and 9 Outputs, 12 Inputs and 12 Outputs or 16 Inputs and 16 Outputs. The 1.2 inch depth, aluminum alloy body and fan-less design makes it ideal for many space and noise sensitive applications. In space constrained systems, the matrices can even be mounted behind other rack-mounted equipment.

The frames are equipped with gold plated screw-locking DVI connectors, dust-proof and also lockable Neutrik Ethercon and high current Speakon power connectors which ensure a robust connection at all times. All outputs supply 500 mA continuous current on DVI +5 V pin to power long distance fiber optical transmitters like Lightware DVI-OPT-TX110.

Thanks to the switchers' non-blocking architecture, any input can be switched to any or more outputs without switching delay or frame latency.

Alternative rack mounting for space saving applications

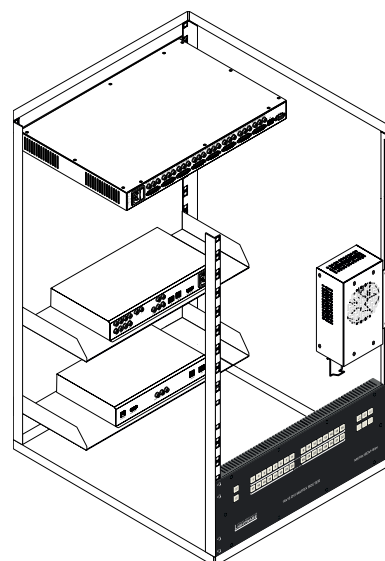

# MX9x9DVI-Slim, MX12x12DVI-Slim, MX16x16DVI-Slim

MX9x9DVI-Slim, MX12x12DVI-Slim and MX16x16DVI-Slim can be controlled via a built-in website, or via LAN or RS-232 using Lightware's Matrix Controller software. All matrices provide Lightware's Advanced EDID Management feature, making it possible to emulate 100 EDIDs, 50 of which are factory preset and 50 are user programmable. The Matrix Controller software contains Lightware's built-in Advanced EDID Editor, which provides the following functions:

- **Function 1:** Advanced EDID Editor can **translate** the binary data into readable english format, which contains every information stored in the EDID data structure and the optional extensions. The report provides a quick and easily understandable overview of all the available settings.
- **Function 2:** **Edit or create a new EDID.** All settings, which are defined in the standards, can be edited on an intuitive user interface. The editing of additional CEA extensions is also supported.
- **Function 3:** **Save** the modified or created EDIDs in different compatible file formats or upload them immediately to the memory of MX9x9DVI-Slim, MX12x12DVI-Slim or MX16x16DVI-Slim.
- **Function 4:** **Download EDID, open EDID from file or view the EDID of your display.** There are three options to open an EDID: they can be downloaded from MX9x9DVI-Slim, MX12x12DVI-Slim or MX16x16DVI-Slim, they can be opened from file and they can be fetched from a display device actually connected to the matrix.
- **Function 5:** A wizard-like interface is also included which makes it possible to create new EDIDs with the most common features just by a few clicks. You only have to specify the desired video format and let the program calculate every other parameter automatically.

## Lightware Device Controller

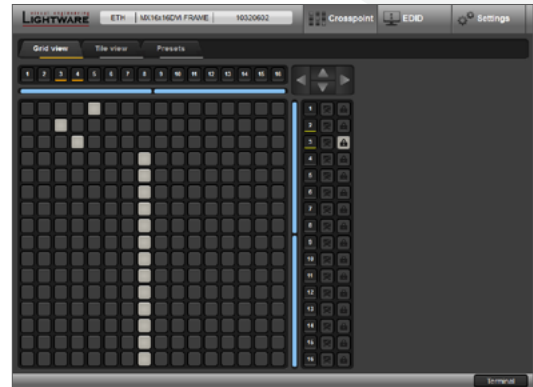

### RS-232; IP or WEB based remote control and monitoring

- Crosspoint switching
- Advanced EDID Management
- Setup and configuration
- Status readout

## Software screenshots

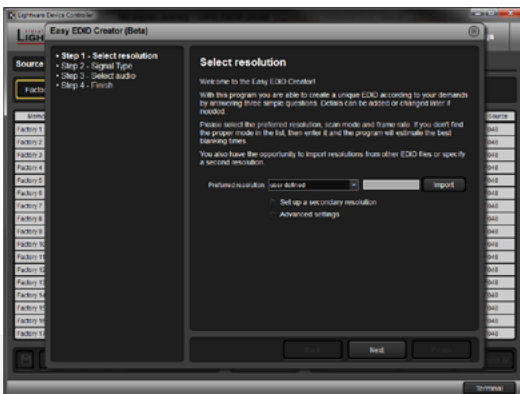

4 step Easy EDID Creator



Adjusting detailed video parameters

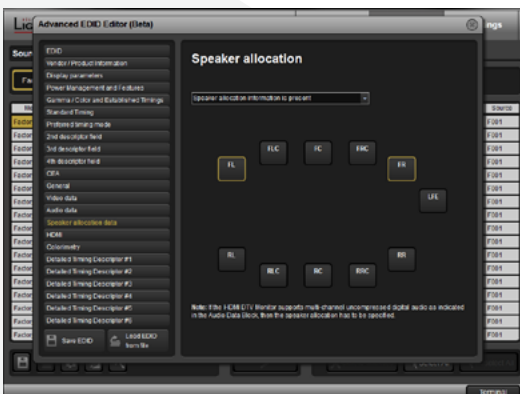

Audio channel setup

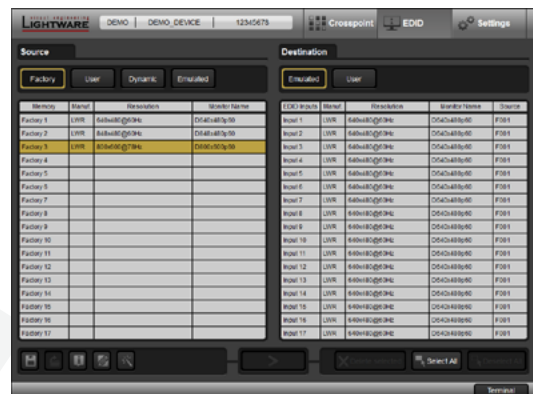

Drag and drop EDID emulating

## Typical application

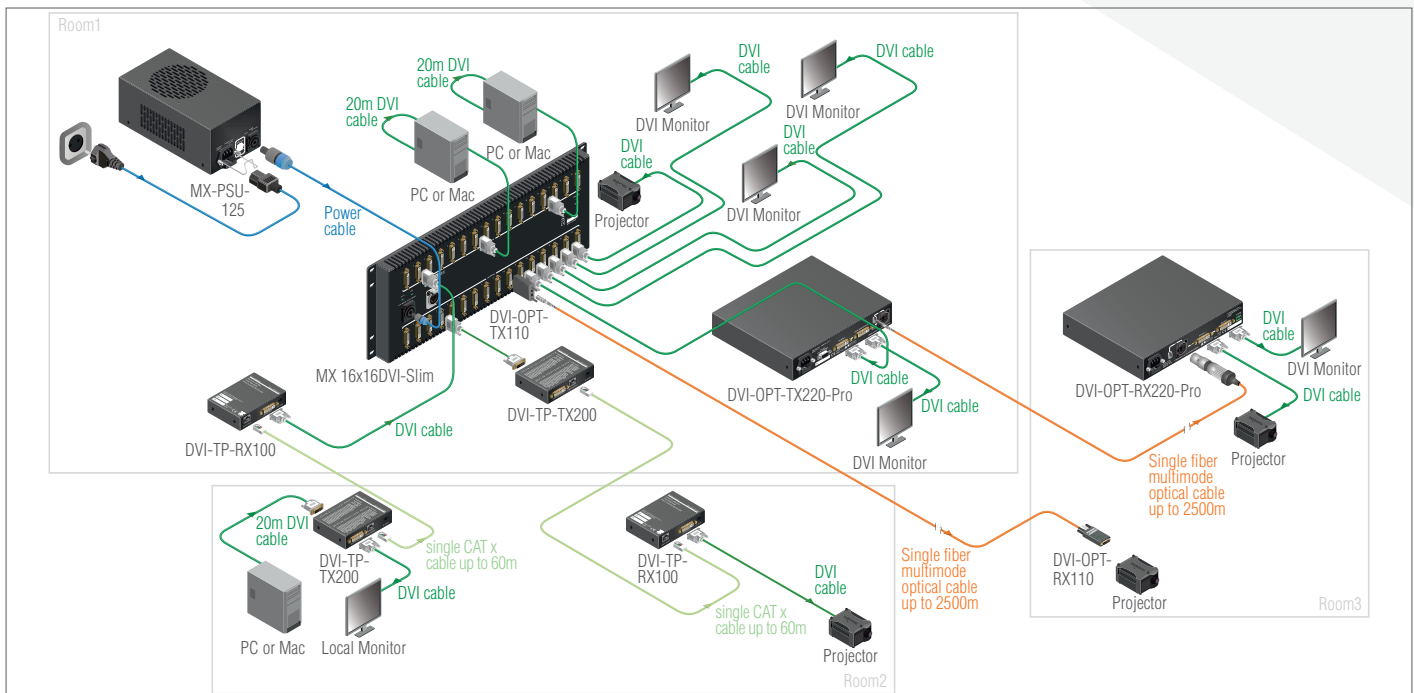

## Applications

- Multiroom video control
- Professional AV systems, conference rooms
- Medical Imaging
- Avionics
- Military

## Features

- Industry's smallest and lightest frame
- No switching latency – zero frame delay
- Routing 9x9, 12x12 or 16x16 DVI 1.0 signals
- 1920x1200 or 2048x1080 maximal resolution
- Gold plated PCB boards and connectors
- Web page hosting capabilities
- Front panel buttons control
- Advanced EDID Management
- RS-232 or RS-422 and Ethernet Control
- Vista Spyder and Barco Encore compatibility

## Control

Front panel buttons:	Yes
RS-232 / RS-422:	9600 Baud Rx; Tx
LAN:	Ethernet 10Base-T or 100Base-TX (Auto-Sensing)
WEB:	Built-in website

## Specifications

Routing:	9x9, 12x12 or 16x16 non-blocking - any Input to any Output(s)
Bit rate:	2.25 Gbit/s per color
Input cable equalization:	+12 dB automatic adaptive
Resolution:	640x480 to 1920x1200 or 2048x1080
EDID Memory:	50 factory preset and 50 user programmable
EDID Emulation:	256-byte extended EDID v1.3
Power:	100 to 240 VAC
Power consumption:	32 W (typical) 72W (max)*
Dimensions:	482W × 32,8D × 176,5H mm
Net weight:	1850 g
Compliance:	CE
Warranty:	3 years

\*maximum power consumption, when all output ports are loaded with +500mA@5V active fiber converters.

## Connectors

DVI:	29-pole DVI-I digital only
RS-232 / RS-422:	9-pole standard D-SUB female
Power:	4-pole Neutrik Speakon
Ethernet:	Neutrik Ethercon

# MX9x9DVI-Slim, MX12x12DVI-Slim, MX16x16DVI-Slim

## Required accessories

- MX-PSU-125 Power supply , with 900mm power cord (Part No: 9134 0005)

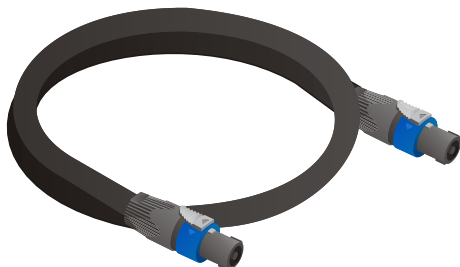

### Power cord

Wire:	4 x 4 mm <sup>2</sup>
Diameter:	14 mm
Length:	900 mm

### MX-PSU-125 Power supply

Input:	90-240V AC, 50-60 Hz
Output:	+3.3V DC 15A, +5V DC 10A
AC connector:	IEC connector with retention lock
DC connector:	Twist and Lock Neutrik Speakon connector
Dimensions:	110W x 200D x 75H mm
Weight:	550 g

## Optional accessories



### DVI-OPT-TX110 and DVI-OPT-RX110

Part No: 9151 0001 (TX), 9151 0002 (RX)

Connector sized DVI over Multimode Fiber Extender.



### DVI-TP-TX200, DVI-TP-TX300 and DVI-TP-RX100

Part No: 9152 0003 (TX200), 9152 0004 (TX300), 9152 0005 (RX100)

DVI signal extenders over single CAT5, CAT6 and CAT7 cable.



### EDID Manager V4

Part No: 9133 0001

HDCP compatible HDMI/DVI EDID Emulator and cable extender with USB control.