

T1230

Passive, 30° Fixed Angle Array Cabinet

TORUS

Features

- 1 x 12" (300mm), & 3 x 1.4" (35mm) HF drivers
- Passive fixed angle array cabinet of 30° vertical dispersion pattern
- Manually adjustable Dynamic Horn Flare™ (between 60°, 90° or 75° Asymmetrical) for flexible horizontal pattern
- Phase plug for increased mid-band sensitivity
- Optimised coverage via DISPLAY 3 and powered by iKON amplifiers
- Plug-and-play system, quick set-up and easy rigging

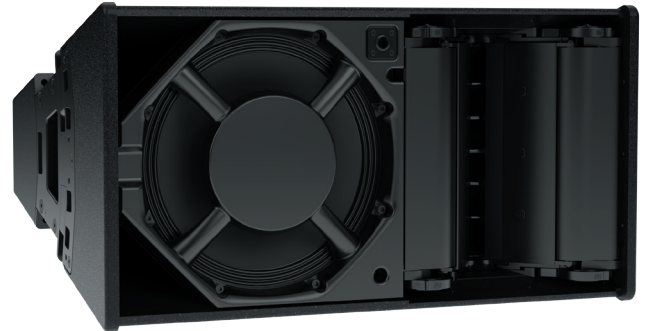

Applications

- Optimised for short to medium-throw live sound and installation applications
- Fills, distributed systems, and centre clusters



For applications that typically require a throw between 15-30m, a full-blown line array is not always practical, optimal or affordable. Conversely, a point source solution may not be sufficient in coverage and SPL. TORUS is a constant curvature array, designed to fill that gap perfectly, combining optimised coverage, SPL and cost efficiency.

T1230 offers a vertical pattern of 30° with a flexible horizontal pattern that can be manually adjusted between 90°, 60° or 75° (Asymmetrical) via the Dynamic Horn Flare™.

T1230 features a 12" (300mm) LF driver and three 1.4" (35mm) HF drivers and includes two NL4 connectors with passive configuration using pins 1+ 1- or 2+ 2- selected via rear-mounted switch. The plywood cabinets are finished in hardwearing Warnex paint with well positioned handles for easy installation and deployment. The integrated rigging suitable for install and touring applications and support horizontal array configurations of up to 180° with a flying frame that can support up to 6 cabinets in vertical orientation. The cabinets also feature a fixing for an external pole-mount accessory,

increasing the flexibility to the max. In addition, T1230 can be supplemented by SX subwoofers and designed to fully integrate with the cardioid subwoofer, SXCF118, for flown and groundstack configurations.

Powered by Martin Audio iKON amplifiers, which support VU-NET and Dante®, T1230 can be modelled in 3D and optimised using DISPLAY 3, allowing different box resolutions as well as automatically optimising filtering to deliver consistent and defined coverage.

Available as standard in black (T1230B) or white (T1230W).

T1230

Passive, 30° Fixed Angle Array Cabinet

TORUS

Technical Specifications

TYPE	Passive 2-way Constant Curvature 30° enclosure
FREQUENCY RESPONSE (with iKON settings)	65Hz – 20kHz ± 3dB, -10dB @ 50Hz
DRIVERS	LF: 12", 3" Voice Coil, Neodymium HF: 3 x 1" exit, 1.4" Voice Coil, HT Polymer dome neodymium compression driver
SENSITIVITY	(2.83V 1m free-field) 99dB
NOMINAL IMPEDANCE	8 ohms
RATED POWER	AES 400W, PEAK 1600W
MAXIMUM SPL (SYSTEM)	126dB continuous, 132dB peak*
DISPERSION	60-75-90° horizontal, 30° vertical
PIN CONNECTIONS (INPUT)	1+/- or 2+/-
PIN CONNECTIONS (LINK)	1+/- and 2+/-
DIMENSIONS	(W) 650mm, (H) 350mm, (D) 442mm (W) 25.59ins, (H) 13.76ins, (D) 17.40ins
WEIGHT	26kg (57.32 lbs)

*Martin Audio continues to specify a crest factor of 2 with 6dB between peak and continuous which best mirrors real-world performance. Simply add a further 6dB for comparison with manufacturers quoting a crest factor of 4 ie. 12dB between continuous and peak.

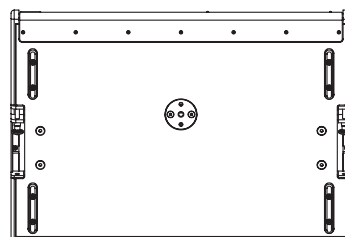
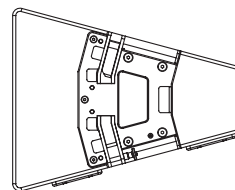
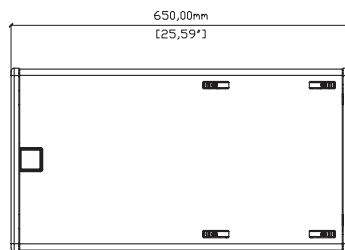
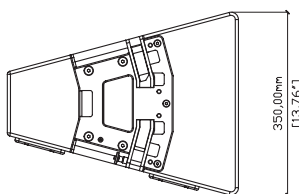
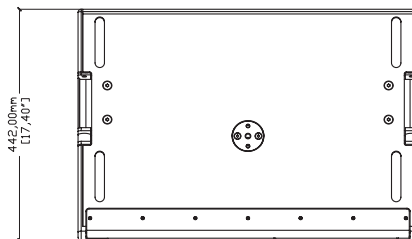
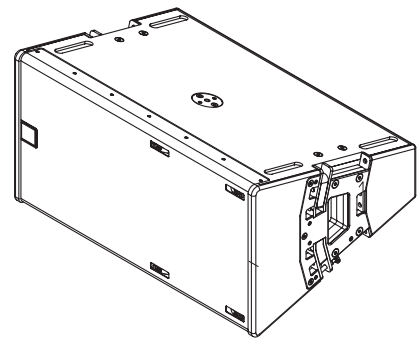

TORUS T1230